

# Elise

48" Dual Fuel Range  
AEL48DF

## Provencal Style



### Oven Features

- Over 6 cubic feet of oven space amongst 3 separate ovens maximize space and reduce energy consumption
- One extra-large 7-Mode Multi-Function™ Oven tailored to your cooking needs with Defrost, Convection, Convection Broiling, Fan Assist Bake, Conventional, Browning and Base Heat
- A second extra-large true European convection oven
- Each large oven has 5 rack positions; the range comes with 4 heavy duty steel racks and one telescoping steel rack for a total of 5 oven racks
- Powerful dual-element Broiler with an 8-pass, 2,300 watt broiler – ready to cook in just 5 minutes
- Glide Out Broiler System™ with Full and Half Broil mode to provide complete coverage with adjustable heights and extendable gliding tray spacious enough to cook six 6-oz steaks at once
- Distinguished brushed stainless steel control knobs give a touch of elegant detail
- Spacious storage drawer with rubber mat to protect and store cookware
- Easy Clean™ Technology with black enamel interior

### Cooktop Features

- Natural Gas cooktop with 5 sealed brass burners each topped with a porcelain enamel finish cast iron flame spreader to provide superb heat distribution and retention
- One center 17,000 BTU brass burner, three 12,000 BTU brass burners and one 6,000 BTU brass burner
- Extra-large 11.75" diameter burner rated 17,000 BTUs perfect for rapid boiling, large stock pots and stir fry
- 6 interlocking matte finish cast iron grates allow for easy removal and cleaning
- Includes an 11" diameter wok ring made of semi-gloss black enamel coated cast iron to cradle a large wok (not included) on the center burner keeping the wok at the perfect height for focused heat distribution
- Extra-large two-piece interlocking center grate
- Four grates interlock above each side burner providing ample space for any pan
- LP Conversion Kit included

### Cooktop Power

A: 12,000 / 2,400 BTU

B: 12,000 / 2,400 BTU

C: 17,000 / 3,400 BTU

D: 12,000 / 2,400 BTU

E: 6,000 / 1,200 BTU

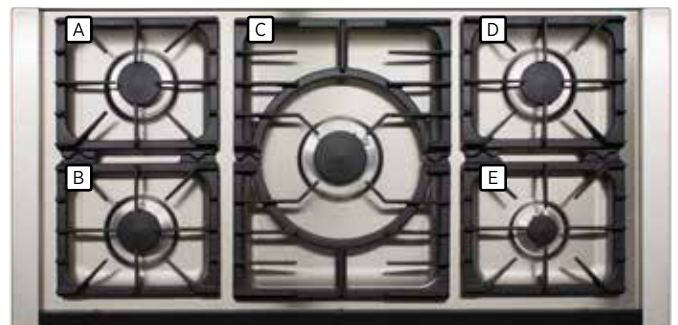

Elise  
by AGA

800-223-3900

www.aga-ranges.com

# Elise

48" Dual Fuel Range  
AEL48DF

*Provençal Style*

## General Properties

Total Oven Capacity	6 cu. ft. - All 3 Combined
Cooking Modes Main Cavity - Right side	Convection Bake 2.8 cu. ft.
Cooking Modes Second Cavity - Left side	Multi-function Oven with 7 Cooking Modes 2.8 cu. ft.
Cooking Modes Third Cavity - Broiler	Dual-element with 8-pass 2,300W .5 cu. ft.
Cleaning Type	EasyClean™ Enamel
Grate Type	Interlocking Matte Cast Iron
Controls	Knobs on fascia
Sealed Burners	Yes

## Technical Details

Circuit Breaker (A)	40A
Volts (V)	240V
Frequency (Hz)	60Hz
Plug Type	4 Wire
Power Cord Length	48"
Energy Source	Electric Ovens and Gas Cooktop
Gas Type	Natural Gas with LP Conversion Kit included
Alternative Gas Type	Liquid Propane

## Dimensions & Weights

Appliance Dimensions	47 <sup>9</sup> / <sub>16</sub> " W x 28 <sup>7</sup> / <sub>16</sub> " D x 36 <sup>1</sup> / <sub>8</sub> " H
Depth with Door Open	46 <sup>1</sup> / <sub>8</sub> "
Weight	357 lbs.
Shipping Weight	390 lbs.
Package Dimensions	49 <sup>1</sup> / <sub>4</sub> " W x 31" D x 46 <sup>1</sup> / <sub>2</sub> " H

## Accessories Included

- |                          |                        |
|--------------------------|------------------------|
| 1 - Enameled broiler pan | 1 - LP Conversion Kit  |
| 1 - Broiler pan insert   | 1 - Storage Drawer Mat |
| 1 - Cast Iron Wok Ring   |                        |

## Warranty

1 Year Warranty, Entire Appliance, Parts and Labor

## Oven Performance

Main Cavity - Right side	2,500W
Second Cavity - Left side	2,500W
Third Cavity - Broiler	2,300W
Broiler Type	8-pass Radiant Heat

## Cooktop Performance

Number of Brass Burners	5
Power of Front Left Burner BTU	12,000 BTU High 2,400 BTU Low
Power of Back Left Burner BTU	12,000 BTU High 2,400 BTU Low
Power of Center Burner BTU	17,000 BTU High 3,400 BTU Low
Power of Front Right Burner BTU	6,000 BTU High 1,200 BTU Low
Power of Back Right Burner BTU	12,000 BTU High 2,400 BTU Low



*Elise*  
by **AGA**

800-223-3900

www.aga-ranges.com

# Elise

48" Dual Fuel Range  
AEL48DF

## Provencal Style

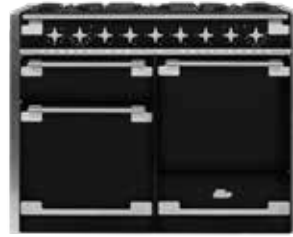

Gloss Black

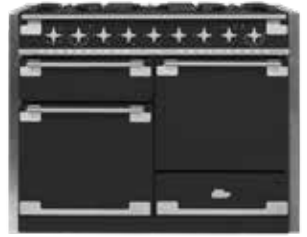

Matte Black

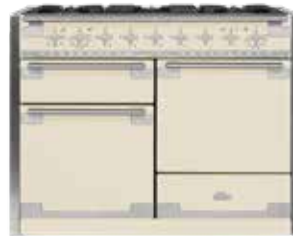

Ivory



White

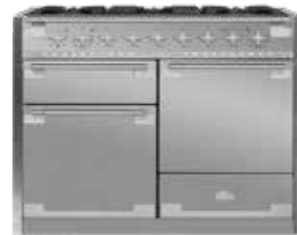

Stainless Steel

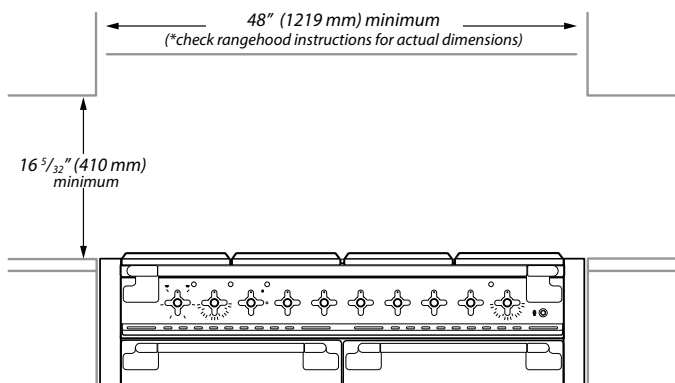
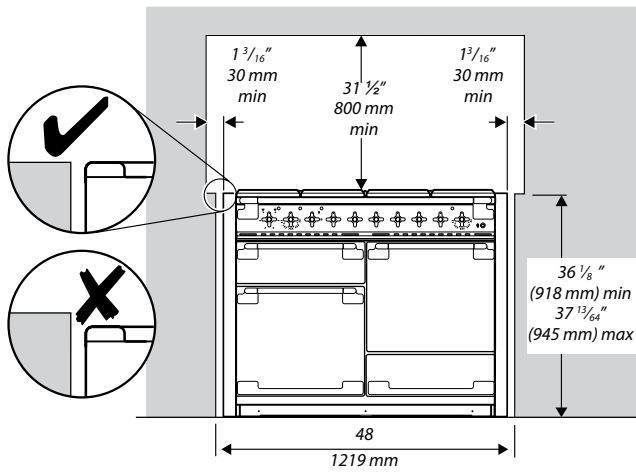

Ordering Details	Model #
AEL48DF-BLK	Gloss Black
AEL48DF-MBL	Matte Black
AEL48DF-WHT	White
AEL48DF-IVY	Ivory
AEL48DF-SS	Stainless Steel



800-223-3900

www.aga-ranges.com